

TPC6000-C1854-L

v1.2 Industrial Panel PC



18.5" HD high-performance industrial Panel PC

- ◆ Support Intel® the 6/7/8/9th generation Core™i3/i5/i7, Pentium, Celeron CPU
- ◆ LGA1151 socket type CPU. Max.65W TDP





specification :

System	CPU	Intel® Core™ 6/7/8/9 th generation i7/i5/i3, Pentium, Celeron LGA1151 type CPU. Max.65W TDP
	BIOS	AMI UEFI 128Mbit
	Chipset	H110
	Memory	DDR4-2400MHz, MAX support 32GB
	Storage	1 x M.2 (M Key 2280 PCIe Gen3x4 Lane), 1 x mSATA
	OS	Support Windows 7, Windows 7 Embedded, Windows8, Windows10, Ubuntu, VXWORKS, QNX
I/O	network	3 x Intel 10/100/1000Mbps controller
	USB	4 x USB3.0 / 2 x USB2.0
	serial port	4 x RS-232 / RS-485 Interface with surge protection, RS485 support automatic flow control
	expansion slot	1 x Mini-PCIe slot,
	I/O port	D8I+8DO Wet contact input (24V) , OC gate output (24V 300mA)
	HDMI	HDMI 1.2
Physical characteristics	Dimension	480mm * 304mm * 74mm
	Cut out size	463mm * 287mm
	Weight	5.9kg
Power	Input voltage	12-24VDC ±10%, Support reverse connection protection, over voltage protection, over current protection
	Idle mode Power Consumption	32Watt
LCD	LCD Type	18.5" HD TFT
	Resolution	1366 x 768
	Colors	16.7MB
	Active Area (W x H)	409.8 x 230.4mm (16.13"x 9.07")
	Backlight	LED
	MTBF (hour)	30000hrs
	Pixel Pitch (H x V)	0.300 x 0.300
	Luminance	250cd/m2
	Contrast Ratio	1000 : 1
	Viewing Angle	(L) 85 / (R) 85 / (T) 80 / (B) 80
Touch screen	Touchscreen type	Capacitive Touchscreen
	Transmittance	≥ 87%
	Response Time (touch pen)	< 5ms
	Surface Hardness	Mohs Hardness 7H
	Click Life	250g / 100,000,000 times
	Multi-touch	10 Points
Environment	Operating Temperature	0 ~ 50°C
	Storage Temperature	-20 ~ 60° C
	Relative Humidity	5~95%@40°C (Non-condensing)
	Vibration	Operating Random Vibration Test 5~500Hz, 1.5Grms@with SSD, follow IEC 60068-2-64
	Shock	Operating 10G peak acceleration (11ms duration), follow IEC 60068-2-27
	EMC	CE/FCC Class B
	Front Panel Protection	IP65 compliant

Dimension: Unit: 480mm * 304mm * 74mm

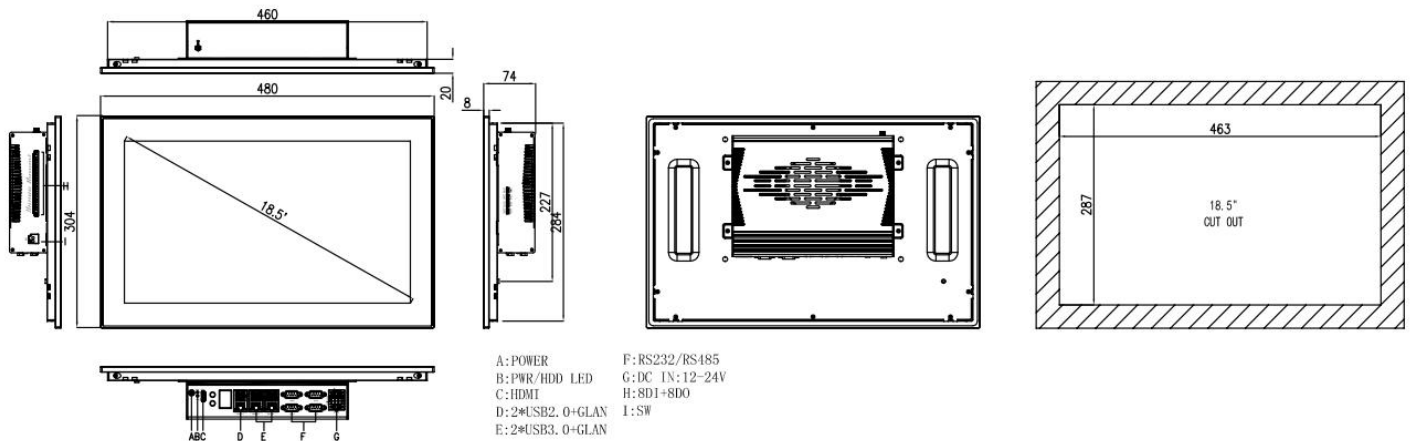

Ordering Information:

Product model	Description
TPC6000-C1854-L	18.5"LCD, 1366*768, 4 x COM(RS232/485), 3 x GLAN, 6 x USB, 8DIO, DC12~24V

Option Items:

Option items	Specification
CPU	Support 6 th /7 th /8 th /9 th generation Intel® Core™ i7/i5/i3 LGA socket type processors Intel® Core™ i3-6100, Dual Core, 3.7GHz, 3MB Cache Intel® Core™ i3-7100, Dual Core, 3.9GHz, 3MB Cache Intel® Core™ i3-8100, Quad Core, 3.6GHz, 6MB Cache Intel® Core™ i5-6400, Quad Core, 2.7GHz, 6MB Cache Intel® Core™ i5-6500, Quad Core, 3.2GHz, 6MB Cache Intel® Core™ i5-6500T, Quad Core, 2.5GHz, 6MB Cache Intel® Core™ i5-8400, Six Cores, 2.8GHz, 9MB Cache Intel® Core™ i7-6700T, Quad Core, 2.8GHz, 8MB Cache Intel® Core™ i7-8700, Six Cores, 3.2GHz, 12MB Cache Please contact sales to check other request.
Memory	DDR4 4G/8G/16G/32G
Storage	Mini SATA SSD64G/128G/256G/512G
2010300008	120Watt Adapter (Input: 100-240V~50-60Hz 2.0 MAX, Output: +12V—10A)
2030100012	Option EU,US,UK...
5040200002	7260 series (mini PCIe)
4G module	(Quectel EC20,EC25,EG25..)